



Seeing beyond

Industrial Quality Solutions

# CONNECTED PORTFOLIO

# 1 Hardware

---

## 06 Bridge Coordinate Measuring Machines

ZEISS SPECTRUM  
ZEISS MICURA  
ZEISS CONTURA  
ZEISS ACCURA  
ZEISS PRISMO  
ZEISS XENOS

---

## 10 Large CMMs

ZEISS MMZ T  
ZEISS MMZ M  
ZEISS MMZ G  
ZEISS MMZ E

---

## 12 Shop Floor CMMs

ZEISS DuraMax  
ZEISS GageMax  
ZEISS CenterMax  
ZEISS PRISMO fortis

---

## 14 Optical Metrology

ZEISS O-SELECT  
ZEISS O-INSPECT

---

## 16 Horizontal Arm CMMs

ZEISS CALENO  
ZEISS PRO  
ZEISS CARMET

---

## 18 Industrial CT- and X-Ray Solutions

ZEISS METROTOM  
ZEISS Xradia Versa & Ultra  
BOSELLO HIGH TECHNOLOGY –  
A ZEISS Company  
ZEISS VoluMax

---

## 22 Stereo and Zoom Microscopes

ZEISS Stemi 508  
ZEISS SterEO Discovery.V20  
ZEISS Axio Zoom.V16  
ZEISS Smartzoom 5

---

## 24 Compound Light Microscopes

ZEISS Axiolab 5  
ZEISS Axioscope Family  
ZEISS Axio Imager 2  
ZEISS Axio Observer

---

## 26 Confocal Microscopes

ZEISS Smartproof 5  
ZEISS LSM 900

---

## 28 Scanning Electron Microscopes

ZEISS EVO  
ZEISS Sigma  
ZEISS GeminiSEM  
ZEISS Crossbeam

---

## 30 3D Scanning Systems

ZEISS COMET  
ZEISS T-SCAN

---

## 32 ZEISS Carbody Solutions

ZEISS ABIS  
ZEISS AIMAX  
ZEISS AIMax twin  
ZEISS AIMAX TWIN UV  
ZEISS Almax cloud  
ZEISS AIMAX Inline  
ZEISS AIMAX BestFit

---

## 34 Surface, Contour and Form Measuring Solutions

SURFCOM NEX  
RONDCOM NEX and NEX Rs  
ACCTee PRO Measuring and Evaluation Software

## 2 Software

---

### 36 **ZEISS Software**

ZEISS CALYPSO  
ZEISS REVERSE ENGINEERING  
ZEISS CALIGO  
ZEISS ZEN CORE

---

### 38 **ZEISS Quality Intelligence**

ZEISS PiWeb  
ZEISS SMART SERVICES  
ZEISS IVY  
ZEISS TEMPAR

## 3 Services & Support

---

### 40 **ZEISS Services and Support**

PRODUCT LIFE CYCLE  
CUSTOMER SERVICES  
ZEISS QUALITY EXCELLENCE CENTER  
TRAINING  
ZEISS Metrology Portal  
ZEISS Metrology Shop

---

### 42 **ZEISS Accessories**

ZEISS Stylus Systems  
ZEISS Adapter Plates  
ZEISS Pallets  
ZEISS OmniFix  
Storage and Set-up

---

### 44 **ZEISS Carfit Components**

ZEISS CARFIT standard components  
ZEISS CARFIT kit systems  
ZEISS CARFIT eMOBEE  
ZEISS CARFIT lite

## 4 Industry Solutions

---

### 46 **ZEISS ONE.STOP.SOLUTION**

---

### 48 **ZEISS Car Body Solutions**

---

### 50 **ZEISS eMobility Solutions**

---

### 52 **Let your EDM machines do the production**

---

### 54 **ZEISS 3D ManuFACT**



This is an invitation to partner with us and enjoy the benefits of a connected portfolio of hardware, software and digital industrial quality solutions thoroughly designed to increase your productivity in the quality lab and beyond. A portfolio of solutions that will enable the highest precision while our Quality Intelligence products will help you turn your measuring data, as well as the data from your entire value chain into a competitive advantage for you and your company.

Discover our flexible and future-proof solutions and accessories for the quality lab and beyond, which will help you prepare for all quality assurance challenges, today and tomorrow. Experience top performance in real-time conditions, with our quality solutions especially designed to operate in production line environments, without compromising

on precision. See for yourself how for ZEISS, a promise made is a promise kept. Navigate our new and unique roadmap of dedicated quality solutions for car body, for additive manufacturing, for EDM machines, and for your electric vehicle business. Experience destruction-free quality control at its best, with our ZEISS X-Ray Series portfolio, to make the invisible visible, measure the unreachable, and reveal the deepest and most hidden defects and to analyze your parts down to their core.



Beyond our products, we invite you to connect to over 100 years of proven success in the industry; to our global network of 32 sales & service organizations, 62 Quality Excellence Centers and 100 business partners. An invitation to connect to our culture of precision, service and productivity, where you, our customer, are at the center of everything we do.

Connect to Productivity with our ZEISS Industrial Quality Solutions.

# Bridge Coordinate Measuring Machines

## Faster and more precise measurements

Measurement results with high accuracy are particularly important for quality assurance. Bridge coordinate measuring machines from ZEISS have a precise probe system that convinces with high measuring speed. The various solutions and systems can be tailored directly to individual requirements.

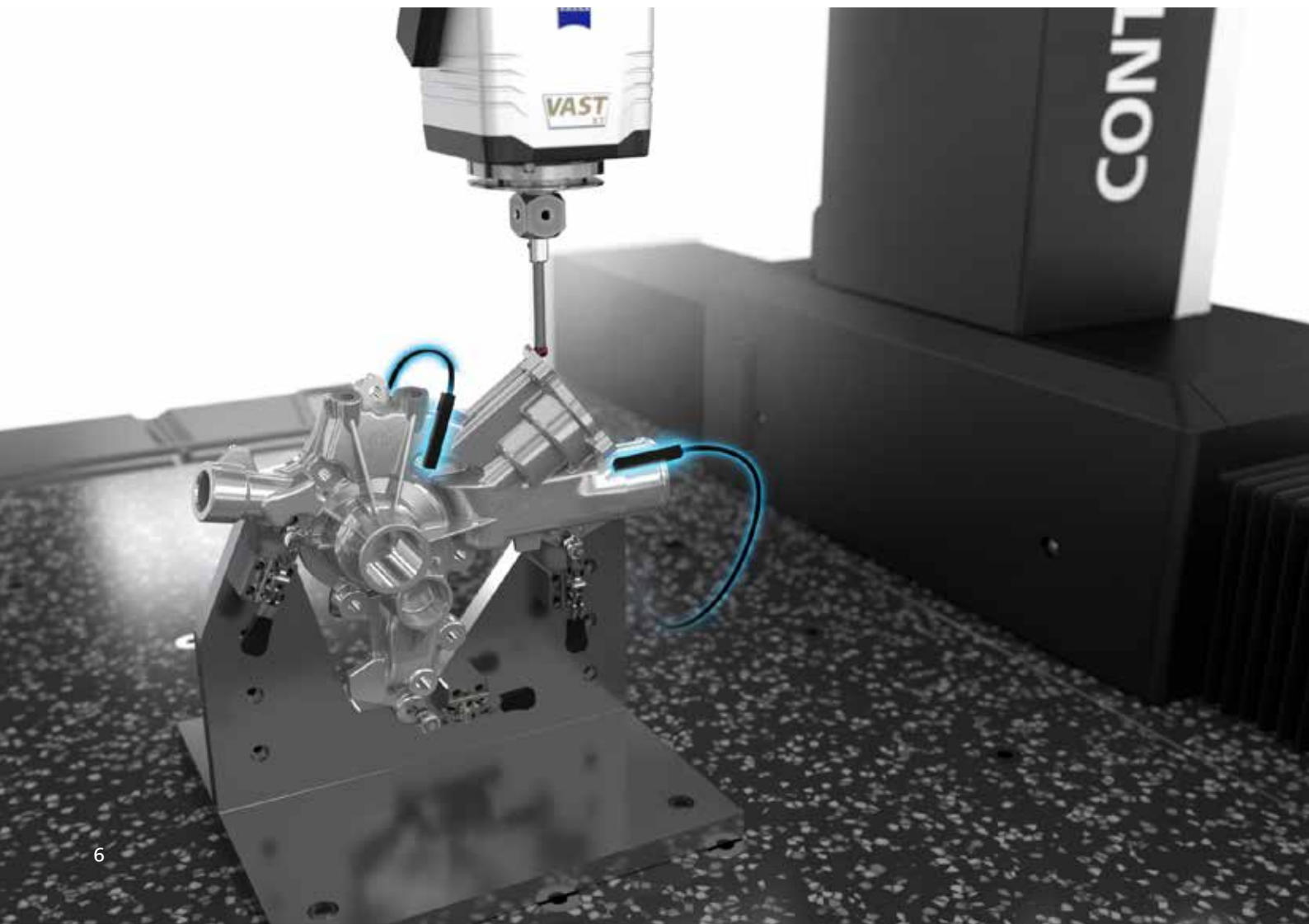

---

## ZEISS SPECTRUM

### Upgrade to trusted measuring results

Your company's production plan needs to be fulfilled? Growth ratios performed? No time for complaints and lowered productivity – caused by missed error detection of defective parts?

With the ZEISS SPECTRUM coordinate measuring machine you will enter a new level of precision and trusted results – at an unmatched price-performance ratio.

---



---

## ZEISS MICURA

### Maximum precision for small parts

ZEISS MICURA is the solution for new requirements in industrial manufacturing, where components are becoming ever more compact and accuracy requirements are increasing. Equipped with the high-end sensor VAST XT gold from ZEISS and Navigator technology, ZEISS MICURA offers active scanning with a measuring accuracy of less than one micrometer. The CMM shows its strengths particularly in small, tightly tolerated and complicated components such as those used in optics or electronics.

---



---

## ZEISS CONTURA

### Prepared for all challenges - today and tomorrow

ZEISS CONTURA enables you to be prepared today for the measurement requirements of tomorrow: The new generation is equipped with the multi application sensor system (mass) and, thanks to a common interface, enables simple switching between different sensor technologies in just a few simple steps. In addition to innovative options such as measuring in four axes using a flexible rotary table, an automated probe changing system or the HTG option (for larger temperature ranges), the device also stands for first-class performance, ergonomics and future security.



# Bridge Coordinate Measuring Machines

## When precision matters the most

For more than 25 years, ZEISS PRISMO has been synonymous worldwide with high-speed scanning and maximum accuracy. PRISMO from ZEISS fully complies with ISO quality standards – a must in a world where precision matters the most.





---

## ZEISS ACCURA

### Tailored to your needs

Are performance and precision your top priorities? With its wide range of configurations, ZEISS ACCURA measuring can be tailored to your needs – and budget. Thanks to its modular design, the CMM is ready to meet the demands of the future. It grows with your requirements on equipment, sensors and software. Pre-wiring for contact and optical sensors, as well as scanning, makes ZEISS ACCURA immediately multisensor capable.

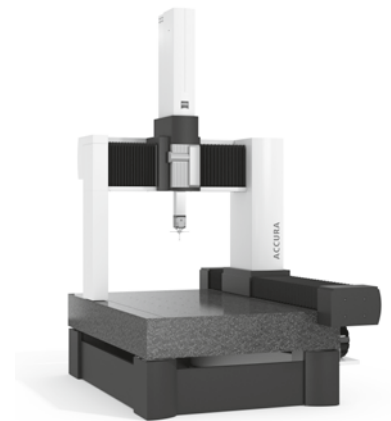

---

## ZEISS PRISMO

### When precision matters the most

Besides the aspiration of not accepting compromises when it comes to precision, ZEISS PRISMO is ideal when maximum demands on precision have to be met.



---

## ZEISS XENOS

### High-end measuring machine for maximum precision

ZEISS XENOS is at home wherever maximum precision is demanded – in the measuring labs of research institutes, the aerospace industry and the optical industry. The high-end machine combines precision at the limits of what is technically feasible with a measuring range of nearly one cubic meter.

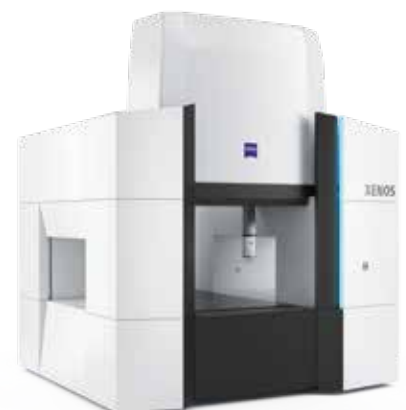

# Large CMMs

## Measure even the largest parts with highest precision

In the aerospace industry, in vehicle and mechanical engineering as well as in many other fields, coordinate measuring machines with a large measuring range are required so that there is no need to compromise when it comes to precision. This is why ZEISS offers a wide range of tabletop, bridge-type and gantry coordinate measuring machines in various sizes.



## ZEISS MMZ T

### fascinating combination of measuring range and precision

With a measuring range of up to 14.8 m<sup>3</sup>, the ZEISS MMZ T offers the largest measuring range from amongst the table bridge-type measuring machines. For example: it enables the highly precise measurement of large gears directly on the shop floor. The open design enables easy loading with a crane and the machine allows workpieces weighing up to ten tons.



## ZEISS MMZ M

### For the most demanding precision requirements

Precise measurements at favorable acquisition costs – this was the goal when developing the ZEISS MMZ M. The coordinate measuring machine is ideal for checking complex workpieces, especially those with tight tolerances. ZEISS MMZ M CMMs are used by mechanical engineers as well as windturbine and gear train manufacturers.



## ZEISS MMZ G

### Unparalleled greatness for large workpieces

Large bridge-type machines in the ZEISS MMZ G line meet the highest demands: they feature the largest measuring range of all measuring machines offered by ZEISS and offer you unparalleled accuracy. This makes the ZEISS MMZ G ideal for checking complex, extremely large workpieces, especially those with tight tolerances.



## ZEISS MMZ E

### Ideal for the flush floor loading of large parts

MMZ E measuring machines from ZEISS are used, for example, in the mechanical engineering, automotive and aerospace industries and for the inspection of satellite technology. They are particularly well-suited for the inspection of large workpieces.



# Shop Floor CMMs

## Excellence in production

Quality assurance should be performed at the site of production. This is how manufacturing errors can best be identified and even avoided in the best case scenario. We not only provide the answer to this customer requirement with our MaxLine, but are continuing to enhance it.



## ZEISS DuraMax

### The right measuring equipment for the shopfloor

ZEISS DuraMax eliminates the need for fixed gauges. Equipped with the VAST XXT scanning sensor from ZEISS, it can even be used to capture contours and freeform surfaces. A rough production environment is no challenge for ZEISS DuraMax – the machine is made for it. ZEISS DuraMax is also available with the HTG option (High Temperature Gradient).



## ZEISS GageMax

### Compact flexibility

ZEISS GageMax measures directly in production and is unaffected by extreme temperature fluctuations and ground vibrations and thanks to the TVA formula, the accuracy of this system can be exactly determined for different temperatures. This measuring machine can also measure unknown curves and freeforms via active scanning.



## ZEISS CenterMax

### Unparalleled stability

ZEISS CenterMax can be directly integrated into a production line. The variable workpiece base makes it ideal for automated loading. Vibrations from processing centers are effectively damped. ZEISS CenterMax is equipped with the TVA formula, which means that the accuracy of this system can be exactly determined for different temperatures.



## ZEISS PRISMO fortis

### No compromises: Even outside the quality lab

ZEISS PRISMO fortis delivers reliable measurements in the toughest conditions, even at temperatures of up to 37°C (optional 40°C). For this reason, ZEISS PRISMO fortis can be integrated into production without additional investment in an air-conditioned measuring room. In addition, ZEISS PRISMO fortis does not guarantee any loss of measuring volume even when using an automated loading system due to an optional U-shaped granite and additional 200 mm free space in the height.



# Optical Metrology

## Simple and reliable

When the product designs limits the use of pure tactile metrology, optical and multi-sensoric metrology-systems can offer a solution. With their high point density as well as state-of-the-art sensors, optical metrology can measure soft or fragile materials and probe in locations out of reach for tactile systems, while guaranteeing high measuring accuracy.





## ZEISS O-SELECT

**Reliable measurement at the touch of a button**

Thanks to fully automatic setting of both illumination and focus, measuring errors due to operator influence are eliminated. At the mere push of a button, ZEISS O-SELECT evaluates the characteristics and documents the results – also in a professional report if needed.



## ZEISS O-INSPECT

**An expert in every discipline**

The O-INSPECT multisensor measuring machines from ZEISS enable you to optimally measure each characteristic – optically or through contact measurement. The special feature: the ZEISS O-INSPECT delivers reliable 3D accuracy compliant with ISO standards at a temperature range of 18 – 30 °C.



# Horizontal Arm CMMs

## Measuring certainty

ZEISS CARMET and ZEISS PRO horizontal-arm measuring machines measure car body parts with reliable accuracy and efficiency – by contact and optically. Is a stable foundation available? How stable are the temperature conditions? How long can the inspection take? ZEISS offers an appropriate and comprehensive solution, including fixtures, software, sensors and service from ZEISS depending on the requirements and environmental conditions at the customer's site.





## ZEISS CALENO

**More than a robot. It's a Hambot**

Maximum versatility and highest performance capabilities – this is what sets ZEISS CALENO Hambot apart. With its combination of powerful optical and tactile sensors it ensures maximum productivity and precision.



## ZEISS PRO

**Fully configurable for your convenience**

ZEISS PRO/PRO T can be very flexibly configured. For example, ZEISS PRO/PRO T can be tuned for economic efficiency or performance depending on your needs – and thus enables maximum performance regardless the task. Regarding measuring volume, design and sensors, ZEISS PRO/PRO T provides maximum flexibility.



## ZEISS CARMET

**Exclusive features for a wide range**

ZEISS CARMET is a total package that leaves almost no requirement unanswered while offering ZEISS quality through and through. The trapezoidal Z column, the user friendly design, the high operating safety, good accessibility and quickly calibratable RDS-CAA articulating probe holder are just some of the highlights that come standard on ZEISS CARMET.



# Industrial CT- and X-Ray Solutions

To examine things, to get to the bottom of them, to get to their core – this desire has always driven science, research, and development. X-ray technology from ZEISS has provided perfect insights for years in these and other areas. When it comes to quality and process control, it reveals what would otherwise remain hidden from even the most watchful of eyes – without destroying the part.



## ZEISS METROTOM

Measure and evaluate entire components with X-ray

With an industrial CT system from ZEISS, you can perform blueprint measuring and defect analysis with only one X-ray scan.

### Technical Data

Accuracy  $2.9 \mu\text{m} + L / 100$



## ZEISS Xradia Versa & Ultra

Industrial X-ray microscopy: Extreme resolution & contrast

ZEISS Xradia Versa & Ultra extends the boundaries of non-destructive 3D X-ray imaging with industry leading resolution & contrast, extensive filtering and in-situ analysis.

### Technical Data

	Versa	Ultra
Resolution	< 500nm	< 50mm



## BOSELLO HIGH TECHNOLOGY – A ZEISS company

2D Radioscopy

This is our industrial 2D X-ray line. The systems are built for tough shop floor conditions and used for automatic defect recognition.

### Technical Data

Throughput < 1 minute / part



## ZEISS VoluMax

X-ray inspections for greater efficiency and performance

ZEISS VoluMax CT systems are designed for applications where many components must be inspected quickly. It can be configured for both manual and automated loading.

### Technical Data

Throughput < 1 minute / part



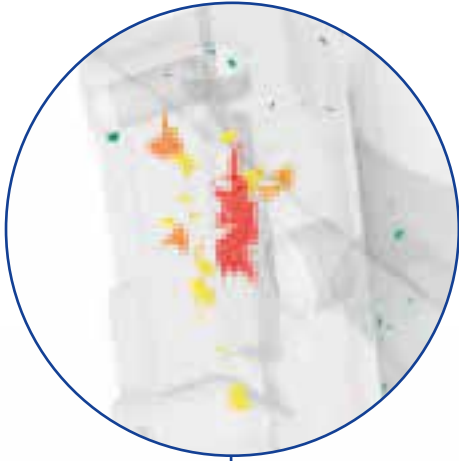

This defect would cause a product recall, resulting in additional costs.

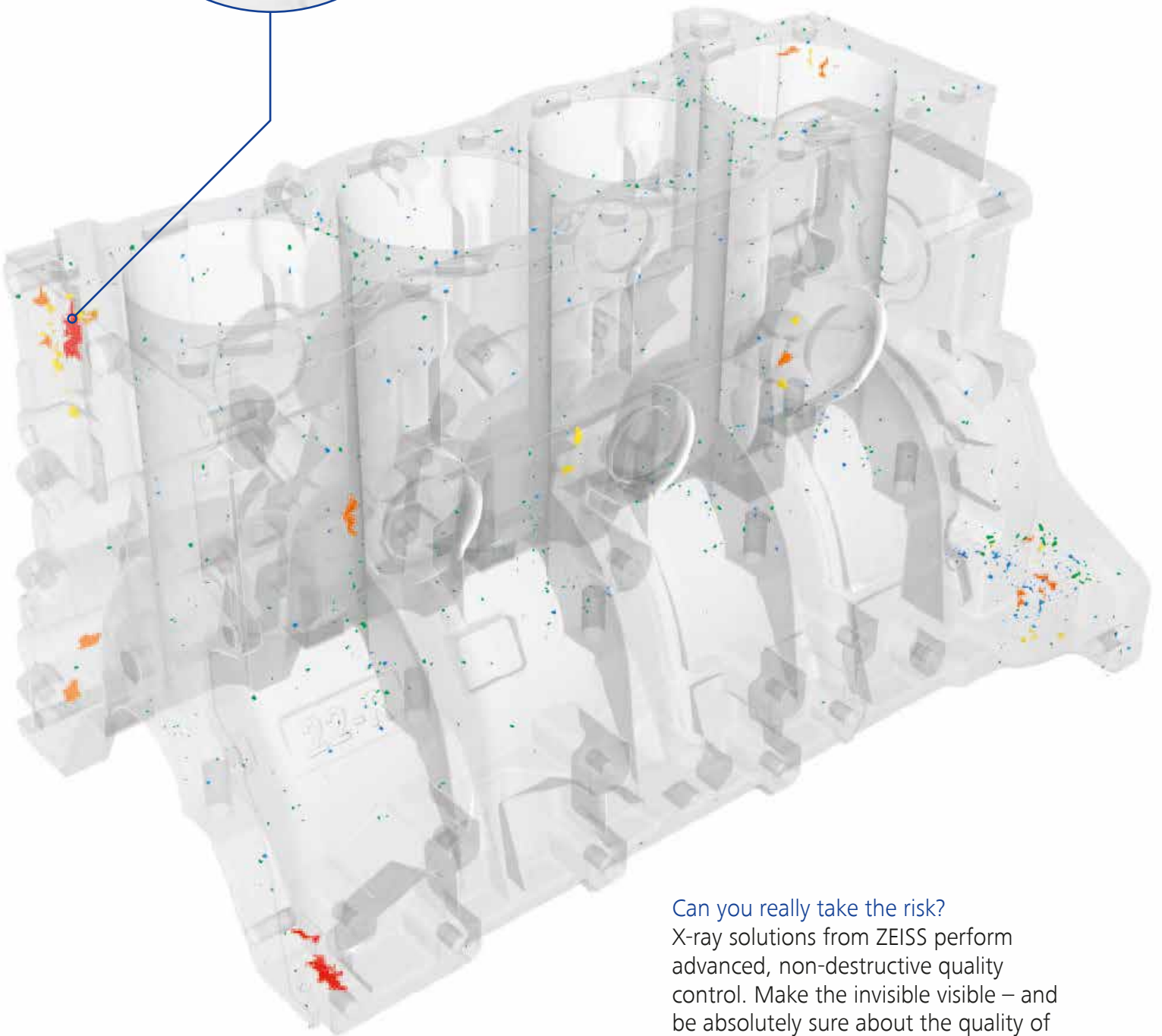

Can you really take the risk?  
X-ray solutions from ZEISS perform advanced, non-destructive quality control. Make the invisible visible – and be absolutely sure about the quality of your parts.

**HIGH-PRECISION METROLOGY & INSPECTION**

LAB	Resolution	Accuracy	Part size	Speed	Part density
METROTOM 800 130 kV	***	*****	***	***	**
METROTOM 800 225 kV	***	****	****	****	****
METROTOM 800 225 kV (HR)	***	****	****	****	****
METROTOM 1500	***	***	*****	****	****



**HIGH-RESOLUTION ANALYSIS & INSPECTION**

LAB	Resolution	Accuracy	Part size	Speed	Part density
Xradia 800 & 825 Synchrotron	*****	-	*	**	*
Xradia 800 & 810 Ultra	*****	-	*	*	*
Xradia 610 & 620 Versa	****	-	**	**	***
Xradia 510 Versa	****	-	**	*	**
Xradia 410 Versa	****	-	**	*	**
Xradia Context microCT	***	-	**	***	***



**FAST & AUTOMATED 2D INSPECTION**

PRODUCTION LINE	Resolution	Accuracy	Part size	Speed	Part density
BOSELLO WRE THUNDER	*	-	***	*****	***
BOSELLO OMNIA	*	-	*****	*****	****
BOSELLO SRE MAX	*	-	*****	*****	*****



**FAST & AUTOMATED 3D INSPECTION & METROLOGY**

PRODUCTION LINE	Resolution	Accuracy	Part size	Speed	Part density
VoluMax 400	***	*****	**	****	**
VoluMax 800 130 kV	***	*****	***	***	**
VoluMax 800 225 kV	*	-	****	*****	****
VoluMax 1500	*	-	*****	*****	****
VoluMax 1500 flash	*	-	*****	*****	****
VoluMax 1500 thunder	*	-	*****	*****	****



# Stereo and Zoom Microscopes

## Inspect and measure the smallest details

The closer you look, the more you see. ZEISS stereo and zoom microscopes are easy to operate, even for inexperienced users, providing you with information on color, morphology, structure, texture and dimensions. Whether in production environments or in the quality lab, fast imaging helps you to make informed decisions and keep quality at the highest level.



## ZEISS Stemi 508

**High-contrast optical inspection with integrated documentation**

ZEISS Stemi 508 is your robust multi-purpose inspection tool for daily work in manufacturing and quality control. It lets you observe and document your components in outstanding image contrast and color fidelity. Various stand and illumination options help you to create an inspection environment that supports both inspection efficiency and the ergonomic needs of your operators.



## ZEISS SteREO Discovery.V20

**Go from largest overview into the smallest details**

Inspect large components like PCBs with exceptional depth perception across the entire 20:1 zoom range. The motorized zoom with an electronically-generated zoom curve lets you take precise control of freely-selectable magnification positions, giving you the advantage of reproducing your image scale with an accuracy of more than 99 %.



## ZEISS Axio Zoom.V16

**Reduce image acquisition times to speed up analysis**

Axio Zoom.V16 is the high resolution, apochromatically corrected on-axis zoom microscope from ZEISS. With a magnification range of 16:1, you can zoom from a large overview (33 mm) down to the smallest detail (0.7  $\mu\text{m}$ ). This is particularly beneficial for automated stitching of large tile images and makes Axio Zoom.V16 the preferred solution for particle analysis and technical cleanliness applications.



## ZEISS Smartzoom 5

**Repeatable inspection and documentation workflows**

Go digital to overcome classical light microscopy challenges and have confidence in your data. The ZEISS Smartzoom 5 digital microscope assists operators with consistent execution of recurring, routine imaging and measurement tasks. Quick and easy to set up, fully automated, and workflow-guided, it is so simple to operate, even novice users will produce results you can trust.



# Compound Light Microscopes

Meet the requirements of material characterization and failure analysis

ZEISS is known for their expertise in developing light microscopes with outstanding optical performance for materials investigation. Each microscope takes a well-defined position in the most comprehensive solution portfolio for material and failure analysis laboratories, to cover the full range of applications from routine metallography to research-grade material examination.





---

## ZEISS Axiolab 5

**Combine metallography with smart documentation**

Axiolab 5 is the right choice if your routine metallography applications place high demands on ergonomic operation and efficient digital documentation. Since the Smart Microscopy concept does not require additional imaging software or even a computer, Axiolab 5 is also the first choice from an economic point of view.



---

## ZEISS Axioscope Family

**Ready to serve both research and routine**

Choose Axioscope if your inspection tasks place high demands on usability, reproducibility and automation – and you also need advanced options for research-grade materials analysis. Axioscope 7, the motorized model in the product family, enables you to automate much of your work process and opens many opportunities for advanced imaging. Benefit from higher productivity, repeatable processes based on predefined parameters, and better comparability of results.



---

## ZEISS Axio Imager 2

**Be open for advanced materials research**

Axio Imager 2 is your system platform tailored to demanding materials analysis tasks, development of new materials as well as quality control and particle analysis. Obtain comparable results and high productivity by automating your workflows. Axio Imager 2 offers a high degree of adaptability in line with your future requirements. The stands are open to expand and cover a wide range of applications.



---

## ZEISS Axio Observer

**Inverted microscope dedicated to metallography**

Take advantage of the inverted construction to investigate many samples in no time at all – or to explore heavy ones, just as efficiently. There's no need to refocus, even when changing magnification or switching samples. Axio Observer combines the proven quality of ZEISS optics with automated components to give you reliable, reproducible results.



# Confocal Microscopes

## Non-contact surface characterization in the sub-micron range

Surface structure influences the functionality of a manufactured part. Low friction surfaces help create more efficient mechanical systems. Quantifying the aesthetic feel of visible surfaces is supported by texture analysis. Monitoring during the manufacturing process is crucial for getting the functionality right. The decision of whether to use a tactile or an optical system depends on the resolution requirements and the sensitivity of the surfaces to be analyzed. ZEISS confocal systems offer sub-micron resolution for roughness and topography analyses of soft and sensitive materials in research, development, and quality control.



---

## ZEISS Smartproof 5

**Fast and robust confocal technology for trusted results**

ZEISS Smartproof 5 combines fast confocal technology for roughness and topography measurements of sensitive surfaces with light microscopy imaging and documentation functions. Dedicated optics enable unrivaled speed and accuracy for 3D data acquisition, providing raw data without pre-processing for results you can trust. Integration of motorization, LED based illumination and optics enable automated operation that yield reliable, certified and user-independent results in production environments – even without additional anti-vibration equipment.



---

## ZEISS LSM 900

**Laser scanning microscope for advanced imaging and surface topography**

LSM 900 is the one instrument you will need for materials research and analysis to characterize 3D microstructures and surfaces. When you upgrade your ZEISS Axio Imager 2 upright light microscope or ZEISS Axio Observer 7 inverted microscope with LSM 900, you will be combining all essential light microscopy contrasting methods for materials with high precision topography – on a single instrument.



# Scanning Electron Microscopes

## Take material investigations to the next level

ZEISS scanning electron microscopes take over when you've reached the resolution or contrast limit of light microscopy, but still need answers. In an industrial quality, failure analysis, or research environment, an SEM system is the solution of choice for metallography and failure analysis applications, due to its ability to provide both high resolution imaging and high spatial resolution elemental chemistry.



## ZEISS EVO

### Best qualified SEM to support industrial quality and failure analysis

Designed specifically for routine inspection and analysis applications, ZEISS EVO offers an operational concept that appeals not only to experienced users, but also to engineers who are not SEM experts. It delivers high-quality data, especially for non-conductive parts and challenging material samples. In combination with the standards-compliant SEM particle analysis solution ZEISS SmartPI, EVO allows particle classification based on elemental composition to reveal the source of contamination.



## ZEISS Sigma

### Field emission SEM technology with an excellent user experience

With the Sigma family you enter the world of high-end imaging: Sigma 300 delivers excellence in price and performance while Sigma 500's best-in-class EDS geometry delivers superb analytical performance. Extract topography, composition and crystallographic information to characterize all your samples. Choose from a variety of detector options to tailor Sigma precisely to your applications: you can image particles, surfaces, nanostructures, thin films, coatings and layers.



## ZEISS GeminiSEM

### Field emission SEM for the highest demands in imaging and analytics

The GeminiSEM family stands for effortless imaging with sub-nanometer resolution and high detection efficiency. Analyze failures in semiconductor materials, examine the microstructure of high-performance steel, characterize polymers, understand the aging process of batteries – GeminiSEM will support the most challenging applications, especially when you have to characterize materials which require low voltages.



## ZEISS Crossbeam

### FIB-SEM for high throughput 3D analysis and sample preparation

Combine imaging and analytical performance of a field emission scanning electron microscope with the processing ability of a focused ion beam (FIB). Prepare high quality samples, like TEM lamellae, using the FIB's low voltage performance, and characterize your samples comprehensively in 3D. Benefit from up to 40 % faster material removal by the introduction of intelligent FIB milling strategies. Enjoy best 3D resolution and leading isotropic voxel size in FIB-SEM tomography.



# 3D Scanning Systems

## Innovative solutions for 3D digitizing

Optical measurement technology from ZEISS combines high-end technology, ergonomics and flexibility. For 3D scanning of free-form surfaces, state-of-the-art sensors are used that provide precise measurement results. With the portable and powerful measuring systems the acquisition of 3D data is very easy. The portfolio includes ZEISS COMET systems and the hand-held laser scanner ZEISS T-SCAN.



---

## ZEISS COMET

**Outstanding flexibility for maximum ease-of-use**

Measure quickly and easily with the ZEISS COMET 3D-sensors: the modular sensor design and project-oriented workflows ensure smooth, efficient measuring processes.



---

## ZEISS T-SCAN

**The complete modular laser scanner solution with perfectly matched components**

The ZEISS T-SCAN series features cutting-edge scanner technology and different measuring volumes, thus increasing precision and saving time for a wide range of applications.



# ZEISS Car Body Solutions

## 100 percent in cycle

ZEISS is a one-stop partner for systematic quality assurance in car body construction: from measurement and inspection technology to the fixtures up to quality data management and service. All products and services from ZEISS are compatible with each other – for maximum quality and productivity

### ZEISS ABIS

**Optical surface inspection of sheet metal panels and bodies-in-white**

ZEISS ABIS is the tailor-made solution for surface inspection (at-line/in-line) of pressed sheet metal parts and car body components as well as the entire car body. Optimized for the use at-line and in-line in the press shop and body shop, the system detects a wide range of surface defects early and directly at the point of origin. Thus, cost-intensive reworking in downstream process steps and losses in the value-added chain can be effectively avoided.



### ZEISS AIMAX

**Digital-optical 3D sensor for sheet metal processing and car body construction**

ZEISS AIMax sensor is used in automated in-line gap and flush inspection and inspects the optical gap on metal and painted surfaces. It has a unique combination of three measuring principles in one sensor: gray scale image processing, multi-line triangulation and shadow analysis.



### ZEISS AIMax twin

**Measures the geometric gap on painted and metal surfaces**

The ZEISS AIMax twin double-head sensor is used to capture the geometric dimensions of the gap and the flush on metal and painted surfaces. Thanks to the dual head, it is possible to inspect the geometric gap in that the sensor looks directly into the gap on painted and unpainted surfaces, from car body construction through painting processes, and all the way to final assembly.





## ZEISS AIMax twin UV

Measures the geometric gap on various surfaces

This sensor takes the capture of gap and flush values one step further: in addition to painted and metal surfaces, it is now possible to obtain these values on non-cooperative and transparent surfaces, e.g. glass and plastics.



## ZEISS AImax cloud

Feature-Recognition of the next generation

ZEISS AIMax cloud optical 3D sensor for generating point clouds is the benchmark in robot-based 3D in-line technology for metalworking and car body construction. This sensor enables the high-precision analysis of complex features in a fraction of a second – ensuring 100 % measurement in short cycle times.



## ZEISS AIMax Inline

Optical sensor for process inspection

ZEISS AIMax Inline is the stationary optical 3D geometry sensor features a wide range of measuring distances and enables solutions for diverse measuring tasks, e.g. quality assurance, location recognition and production-control jobs.

## ZEISS AIMax BestFit

Optical 3D geometry sensor for process inspection

ZEISS AIMax BestFit is the optical sensor is suitable for particularly difficult-to-reach areas. It can also be used in stationary fixed sensor cells and directly on the robot. The compact size enables a large number of sensors to be integrated in a small space.



# Surface, Contour and Form Measuring Solutions

ZEISS works with the Japanese measuring machine manufacturer ACCRETECH, a leading provider in the field of surface, contour and form measuring machines. Form and surface machines are seamlessly integrated into the industrial measuring technology line from ZEISS. This partnership ensures the highest quality, innovative solutions and a global service network for our customers.



## SURFCOM NEX

One system for surface and contour measurement. SURFCOM NEX machines use the same base column. Only the sensors are different. By purchasing a sensor, you can turn your surface measuring instrument into a contour measuring system – or vice versa. Furthermore, additional sensors can be retrofitted, e.g. a hybrid sensor or a white light sensor.



### Sizes

<b>X tracing driver</b>	100 or 200 mm
<b>Measuring height</b>	250, 450 or 650 mm
<b>Base plate</b>	600 x 450 mm or 1,000 x 450 mm

## RONDCOM NEX and NEX Rs

### RONDCOM NEX

Highly-accurate form tester with the highest accuracy in its class and a wide range of applications



### The RONDCOM NEX Rs

Highly-accurate form measuring machine with a special rotary table for precisely measuring roughness and roundness on the R, T and Z axes.



## ACCTee PRO Measuring and Evaluation Software

### Software for surface, contour and form

For surface, contour and form measurements, there is one software that covers all of these: ACCTee PRO. A menu-guided user interface, automatic functions, wizards and help functions make it particularly easy for beginners and experts to use ACCTee PRO. Re-evaluation at the push of a button expedites data analysis.

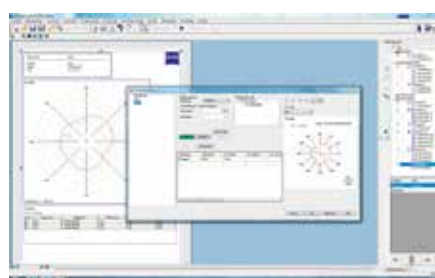

The ACCTee PRO software interface

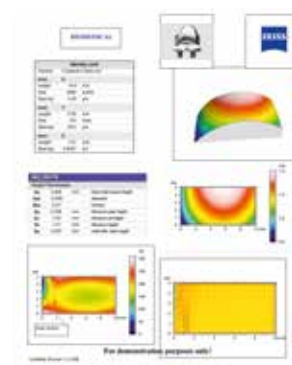

Surface topography measurement

# ZEISS Application Software

## Easy Solutions to Challenging Tasks

ZEISS Industrial Quality Solutions is bringing companies into the future with smart software packages that accelerate production, simplify communication, provide transparency and ensure reliable support anytime, anywhere. Our product portfolio shows that we can help you not only to obtain the most precise measuring data, but we can also help you manage it too.



## ZEISS CALYPSO

**The easy way to get from the drawing to the measurement**

Generate measurement plans with ease and convenience – and in any order you want. Creating the measurement plan is easy to learn, target-oriented and efficient. The separation of characteristics and features makes the software more flexible, faster and more user-friendly.

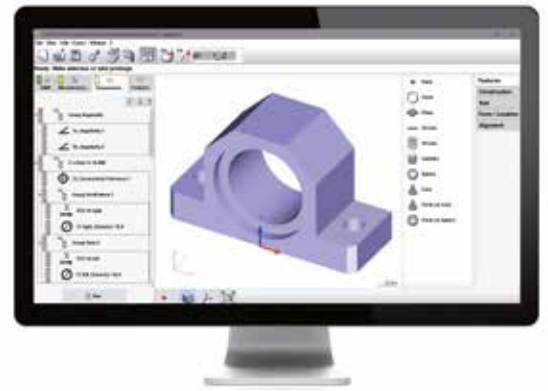

## ZEISS REVERSE ENGINEERING

**Reverse engineering, tool correction and volume calculation**

Achieve perfection, 50 % ahead of time. Companies can significantly reduce the number of iteration loops for tool correction with ZEISS REVERSE ENGINEERING software, making their production processes more efficient. Also, CAD-models can be easily generated and volumes can be calculated quickly.

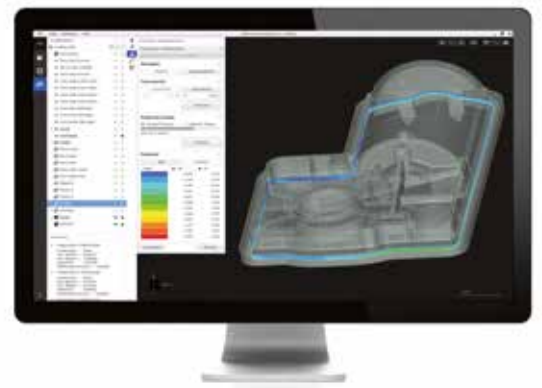

## ZEISS CALIGO

**Universal metrology software focused on freeform surfaces**

Specialist for freeform surfaces. By focusing on the measurement of freeform surfaces, ZEISS CALIGO is primarily intended for users in car body construction. The software is easy to use and offers powerful data processing tools that simplify quality assurance.



## ZEISS ZEN CORE

**Connected microscopy in material and quality labs**

ZEN core is the most comprehensive suite of imaging, analysis, and data connectivity tools for multi-modal microscopy in connected laboratories. Improve your lab's efficiency through automated image segmentation, contextual data analysis, and centralized data management. ZEN core enables the correlation of light and electron microscopy in multi-modal workflows and provides connectivity between systems, laboratories, and locations.



# ZEISS Quality Intelligence

## Easy Solutions to Challenging Tasks

Measuring, evaluation and management software enables you to increase the performance of all your metrology operations.

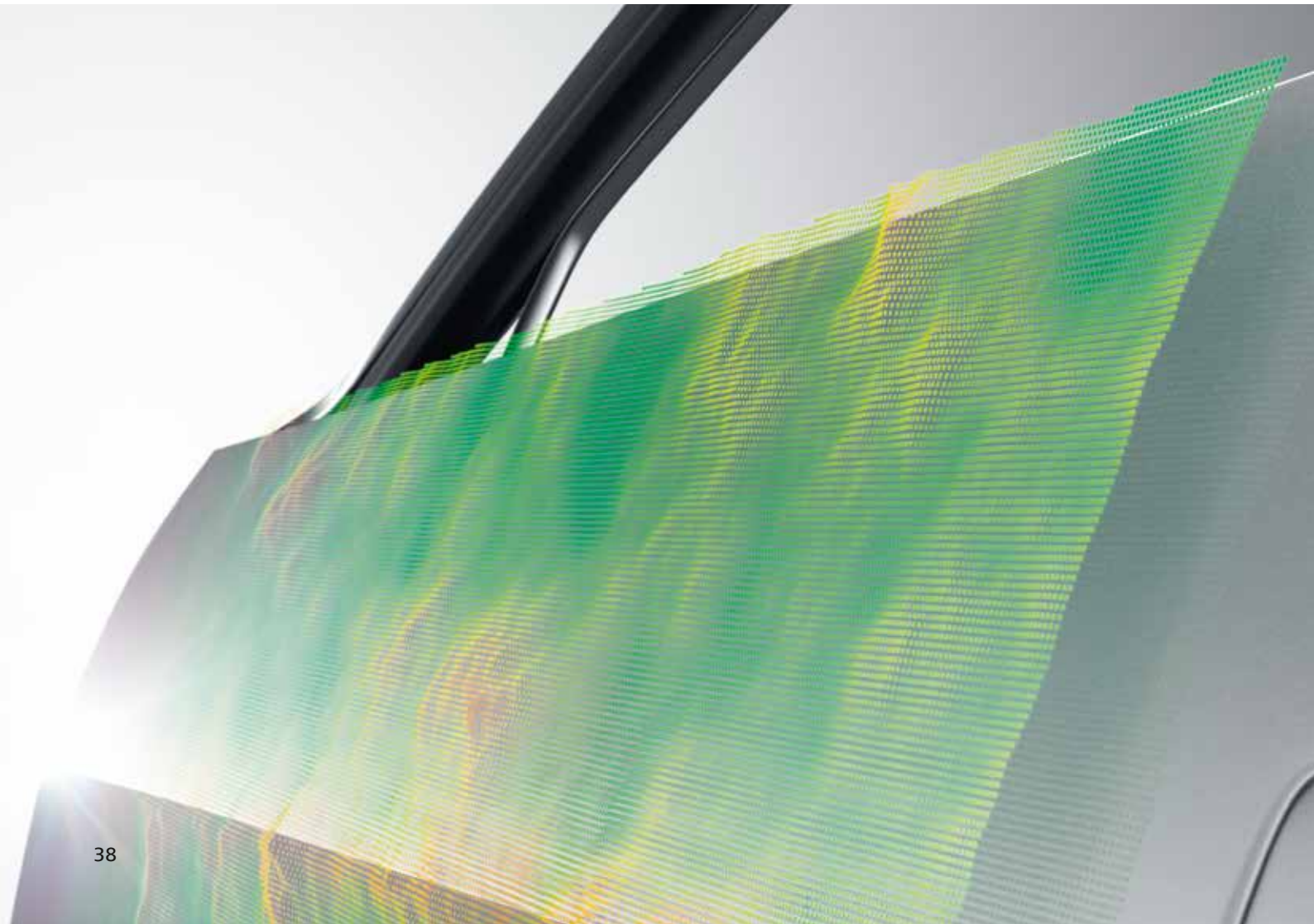

## ZEISS PiWeb

**Perfect control of all important data. Everywhere.**

Everywhere. ZEISS PiWeb is a scalable IT solution for quality data management. With the database-supported versions ZEISS PiWeb sbs and ZEISS PiWeb enterprise, you can organize the information flow resulting from Industry 4.0 and therefore enhance the quality of your products and productivity. With ZEISS PiWeb App, you can access and analyze your measurement data on the go.

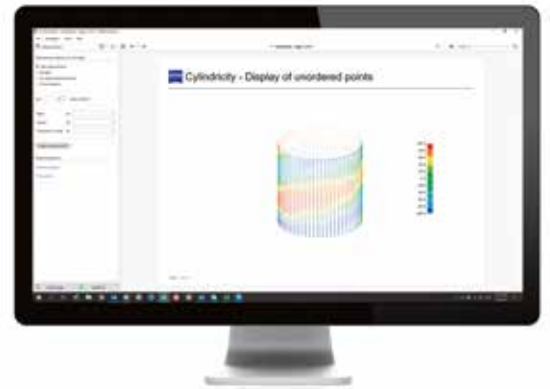

## ZEISS SMART SERVICES

**Connect to the Future of Service**

In the age of industry 4.0, connectivity is key. Unlock the full potential of your ZEISS measuring solutions – and maximise their capability – with ZEISS Smart Services, our new digitally enhanced service portfolio. The ZEISS connectivity solution helps you to achieve optimal uptime with full transparency and realtime access to expert ZEISS support.

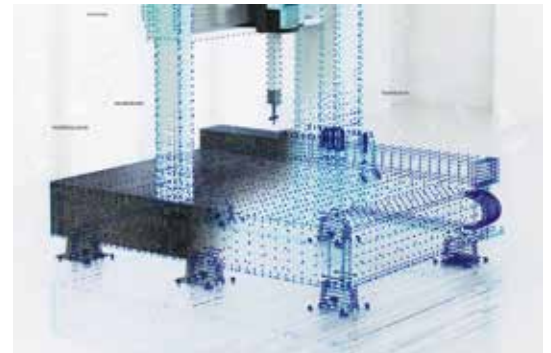

## ZEISS IVY

**All your measurement system data at a glance**

Obtain a complete overview of the status of your measuring systems and identify defects before they occur. ZEISS IVY offers you a future-proof digital solution for networking all your global and local measuring systems.



## ZEISS TEMP PAR

Coordinate measuring machines only reach their maximum precision if temperature, temperature gradients and air humidity are within certain limits. All-round monitoring of the measuring environment is child's play with ZEISS TEMP PAR. This is because it measures and logs all the values which are relevant for precision without any action on your part.



# ZEISS Services and Support

## Extensive support for your metrology challenges

As a comprehensive solutions provider, ZEISS remains at your side independent of the purchase of a measuring system. From measuring services and training to enhanced application support – only ZEISS Industrial Quality Solutions is able to offer you the right expertise at all stages of the product life cycle.

### PRODUCT LIFE CYCLE

**Full support through all stages of your machine's lifecycle**

The ZEISS Services and Support team is comprised of highly-trained experts ready to solve your metrology challenges. Count on us with contract measurements, project assistance and enhanced application support during all the stages of your ZEISS product life cycle. We are your trusted and reliable long-term partner all around the world.



### CUSTOMER SERVICE

**Connect with an expert**

Our Customer Interaction Center is your first stop for all your support needs. If you have a question about your measuring machine, software, applications or training, we have the answer.





---

## ZEISS QUALITY EXCELLENCE CENTER

**Measuring services in your area**

Experience our broad portfolio of measuring services in our more than 60 locations worldwide. We offer a solution for your toughest measuring challenge so that you can focus on your core business.



---

## TRAINING

**I am the solution.**

The ZEISS ACADEMY METROLOGY offers online and classroom training tailored to your needs. Receive the most up-to-date knowledge and become an indispensable asset in your company: become the solution.



---

## ZEISS Metrology Portal

**One link. One login. One stop.**

From software download, to the webshop to the ZEISS community – our online portal offers digital services that simplify your daily life in quality assurance.



---

## ZEISS Metrology Shop

**Just grab it online.**

Accessories, trainings and more at your fingertips. Order your equipment quickly and easily online with the ZEISS Metrology Shop and benefit from functions such as express delivery or special payment methods.



# ZEISS Accessories

## Exploiting your full metrological potential

ZEISS accessories are perfectly matched to your metrological requirements. Whether rotary connection elements, clamping devices or cabinets for the safe storage of your styli - with our accessories, you can fully make use of your metrological potential.

---

### ZEISS Stylus Systems

The stylus system plays a central role in tactile measurement technology. It is the first point of contact to your workpiece. From diamond styli to angle setting devices – the stylus system accessories from ZEISS were developed to meet the special requirements of your measuring tasks.



---

### ZEISS Adapter Plates

Adapter plates are the central interface between the stylus system and the probe. Only original ZEISS adapter plates have a programmed ID chip with which the options "Quick stylus change" or "Fly Scan" can be used. This guarantees higher productivity.



---

## ZEISS Pallets

With pallets, workpieces can be clamped away from the measuring device and in advance of the measurement. The loaded pallets can then be aligned on the measuring device within a few seconds – without having to be calibrated again.



---

## ZEISS OmniFix

With our clamping devices you can clamp your workpieces safely onto your measuring device. We offer clamping devices for tactile and optical measurements as well as for CT systems. We also offer modular systems with which you can create individual clamping systems.



---

## Storage and Set-up

With ZEISS equipment, you can ensure the right conditions in your measuring room. Storage and set-up options specially designed for quality assurance protect sensitive accessories from contamination and damage.



# ZEISS CARFIT

## Fixtures

Fixtures – versatile applications for any measuring process

The ZEISS CARFIT fixtures portfolio is based upon standard components and standard production processes. Out of these basic elements customized fixtures and Meisterbock systems are manufactured, which enable the customer multiple cost savings and slim production processes.

### ZEISS CARFIT standard components

#### Modular components system for inspection fixturing

The ZEISS CARFIT system is a modular fixturing system to design and manufacture measuring applications for quality insurance within the automobile and aerospace industry. Based on nearly 25 years of knowledge and experience the modular ZEISS CARFIT fixtures are manufactured according to customer requirements.



#### Technical Data

CAD library available with all components as 3D models in CATIA and NX

### ZEISS CARFIT kit systems

#### Ready-to-use kit systems for small to medium needs

ZEISS CARFIT kit systems consist of standard components entirely. They are developed for small to medium fixturing needs. A wide variety of ZEISS CARFIT kit systems enables the customer to build standard fixturing devices on their own.



#### Technical Data

Different kit systems available, packed in aluminium suitcase, with additional accessories

## ZEISS CARFIT eMOBEE

### The mobile honeycomb gridplate with e-drive

Autonomous, flexible and agile: the omnidirectional, self-propelled CARFIT eMOBEE honeycomb gridplate is revolutionizing the loading process by providing sustainable support for automated processes in the measuring lab. The lightweight plate is constructed in honeycomb design and can be operated either manual or automatic.

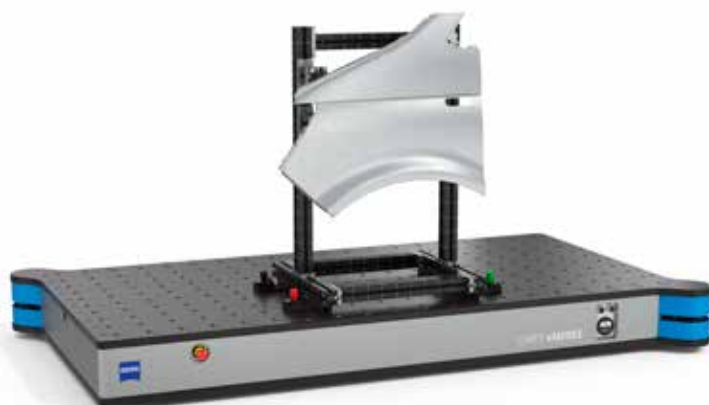

#### Technical Data

Dimensions: from 2000 mm x 1000 mm - 5000 mm x 2000 mm  
 Operation: manual or automatic / Drive: electric motor  
 Grids available: 50 mm x 50 mm, 100 mm x 100 mm, 200 mm x 200 mm

## ZEISS CARFIT lite

### The simple holding fixture for small to mid-sized parts

Thanks to its simplified and standardized modular system architecture, ZEISS CARFIT lite makes it possible to quickly assemble customized fixtures for small to mid-sized parts when performing optical inspections. With the development of this solution ZEISS is expanding its portfolio by adding a fixture system that enables significant cost savings.



#### Technical Data

CAD library available with all components as 3D models in CATIA,  
 degree of standardization: 100 %, up to 95 % can be retooled

# ZEISS ONE.STOP.SOLUTION

## A modular system with endless possibilities

ZEISS not only designs and develops measuring systems for quality assurance, we also give you the confidence of knowing you have a reliable partner at your side. Whether for software solutions, fixtures, loading systems, accessories, reporting or integration into automated production lines, ZEISS is your one-stop shop for getting the most out of your measuring and testing systems.

### ZEISS Team

An interdisciplinary team of ZEISS experts takes individual components to develop a customized, comprehensive solution just for you. Joint project planning and application know-how make it possible to efficiently optimize system loading in the measuring lab or in production.

### ZEISS Inspection and Measuring System

The ZEISS PRISMO stands for maximum accuracy, even in a harsh production environment. Around the world, the coordinate measuring machine is seen as synonymous with high-speed scanning and outstanding precision. The combination of optical and contact sensors or the ZEISS ROTOS roughness sensor and a contact sensor further increases the flexibility of the entire multi-sensor system. This makes it possible to effectively capture size, form, position and surface measurements on one machine and all without re-fixturing.

### ZEISS Engineering

ZEISS Engineering encompasses process automation, component handling more generally and, as shown here, manual loading systems. The ZEISS rotating set-up station enables you to switch out workpieces that have already been inspected with those that still need to be tested – at exceptional speed. The measuring system itself is not blocked as parts are mounted and dismounted. While the measurement is being performed, the operator has time to unclamp the inspected part, remove it and fixture a new one, significantly increasing workpiece throughput.



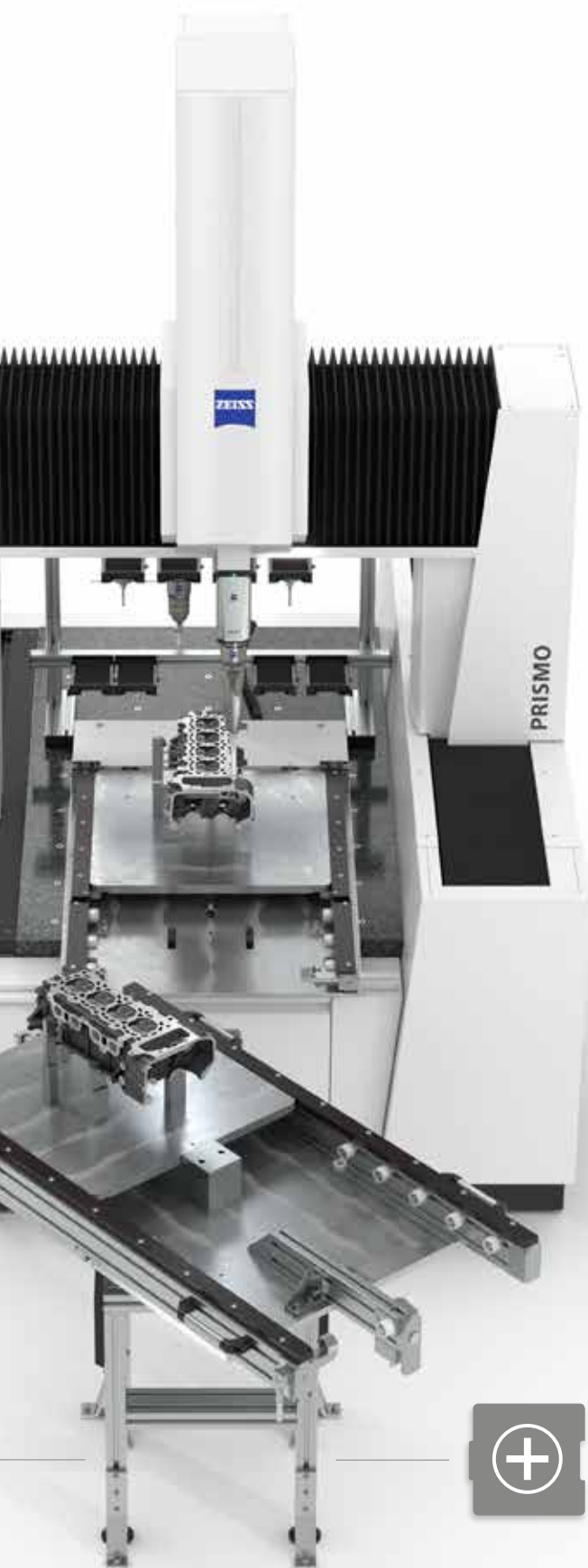

### ZEISS Software, IT Integration and Programming

As a matter of course, ZEISS FACS enables the integration of routine measuring applications in automated processes, frequent random sampling and 100 % inspection. The simplified user interface allows the operator to start measurement runs at the push of a button. ZEISS CALYPSO operates unnoticed in the background, preventing operator errors. ZEISS PiWeb displays and assesses measurement values using graphical and statistical evaluations.



### ZEISS Accessories and Services

The automated probe changing magazine ZEISS ProMax provides your styli systems outside the measuring space of your measuring machine for automated probe changing. This ensures using your measuring volume optimally for your workpiece and the movement path of the measuring head without the risk of collision.

The ZEISS fixtures, clamping systems and pallets guarantee the repeatable fixation of workpieces.



# ZEISS Car Body Solutions

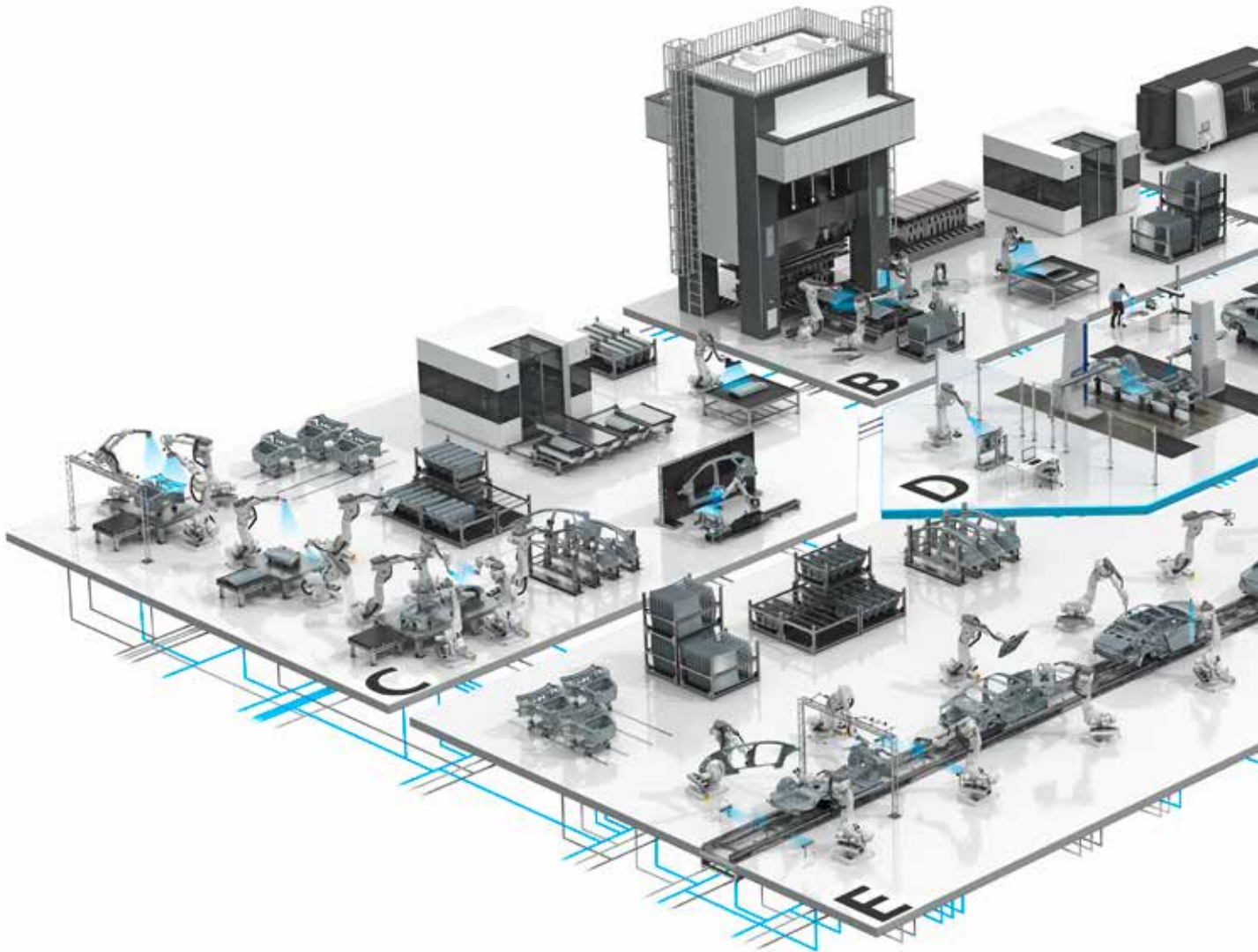

## A Toolmaking

### ZEISS T-SCAN Scanning System

Manual 3D digitization of the press part mold with a hand-held scanner and tracker.

### ZEISS COMET

At-line 3D analyses of individual press part molds.

## B Press Shop

### ZEISS AIBox

Full-surface digitization, measurements of functional dimensions and features along with CAD comparisons – at-line.

### ZEISS ABIS At-line

Random sampling for surface inspections of pressed parts – at-line.

### ZEISS ABIS In-line

100 % inspection of pressed part surfaces in the press line.

## C Component Manufacture in Car Body Construction

### ZEISS ABIS

Random sampling for surface inspections of hang-on parts like doors, hoods, trunk lids and fenders using a robot-based sensor.

### ZEISS AIBox

with ZEISS Loading System Full-surface digitization.

### ZEISS AIBox flex and ZEISS CARFIT Fixtures

Robot-based modular measurements and digitization of side parts and fenders.

### ZEISS AiCell trace

with AIMax cloud Correlation-free in-line measuring cell for real-time process monitoring

### ZEISS AiCell with AIMax cloud

In-line measuring cell for 100 % real-time process monitoring

### ZEISS AiCell with AIMax

In-line measuring cell for 100 % real-time process monitoring.

## D Series and Analysis Measuring

### ZEISS AiCell

with AIMax or AIMax cloud Offline station for programming without interference of the ongoing production process.

### ZEISS PRO with ZEISS EagleEye

Analysis, correlation and series measurements of body shells, hang-on parts as well as analyses of finished vehicles.

### ZEISS T-SCAN Scanning System

Manual 3D digitization with a hand-held scanner and tracker – offline.



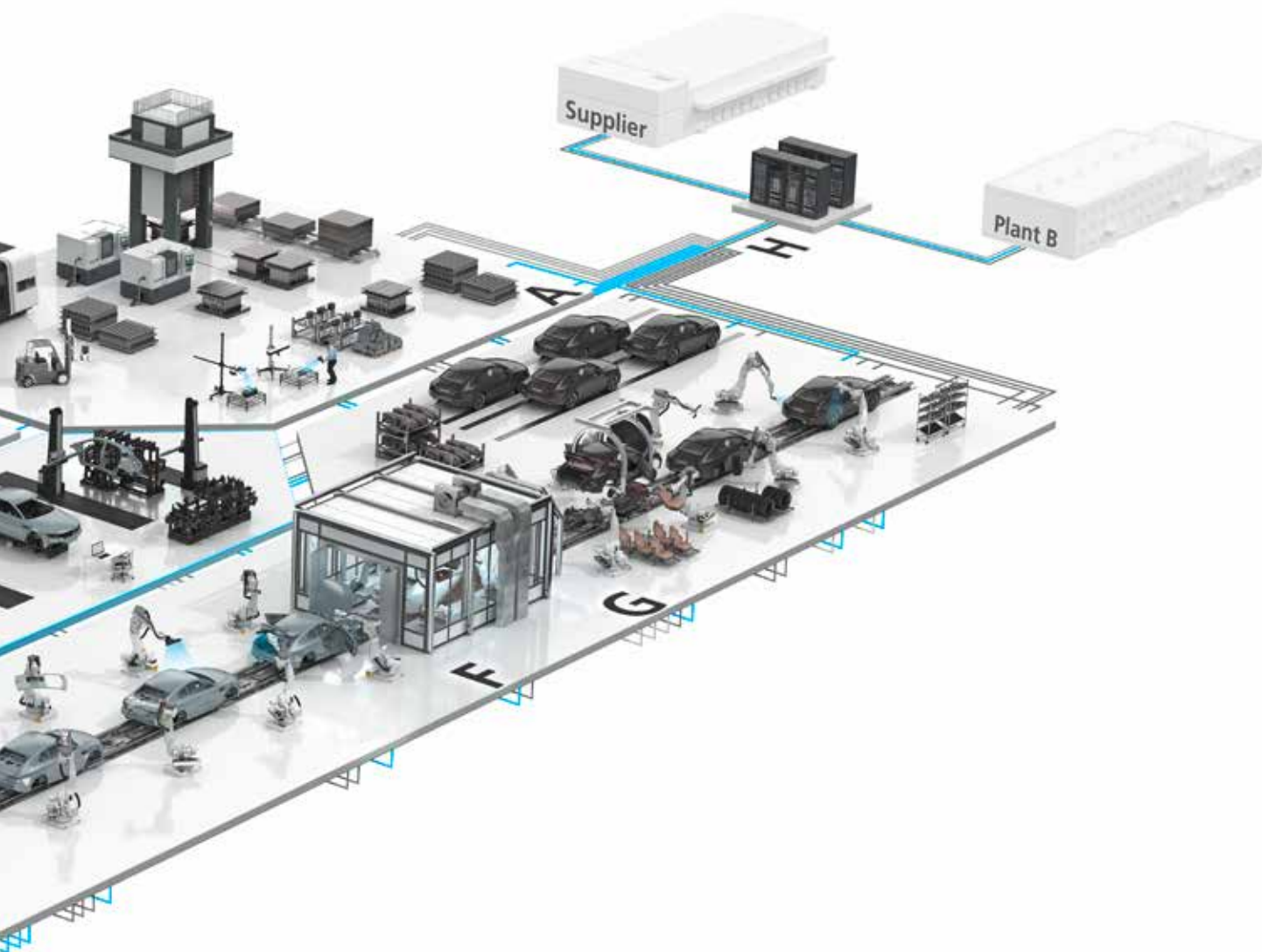

Center	E Complete Car Body	F Paint Work	G Final Assembly	H Quality Data Networking
<p><b>ZEISS External Matching Equipment</b> Qualify and optimize assembly sequences and the individual parts.</p> <p><b>ZEISS CALIGO</b> The ZEISS offline software for freeform surfaces, digitization, simulation and analysis in car body construction.</p> <p><b>ZEISS Matching Equipment "such as ZEISS CARFIT Meisterbock" for Assembly</b> Qualify and optimize joining sequences and the individual parts.</p> <p><b>ZEISS CARMET</b> Analysis and correlation measurements.</p>	<p><b>ZEISS In-line Fixed Sensors:</b> ZEISS AIMax In-line and ZEISS BestFit Fixed sensors enable solutions for a wide range of measuring jobs.</p> <p><b>ZEISS AICell trace with AIMax cloud</b> Correlation-free in-line measuring cell for real-time process monitoring of complex characteristics.</p> <p><b>EISS AICell with AIMax</b> In-line measuring cell: capture gap and flush on the entire car body.</p> <p><b>ZEISS ABIS In-line</b> 100 % surface inspection of the entire car body</p>	<p><b>ZEISS AICell with AIMax</b> In-line measuring cell once paint work is completed: capture flush and gap on the entire car body.</p>	<p><b>ZEISS AICell with AIMax</b> In-line measuring cell in final assembly: capture gap and flush on the finished vehicle on wheels.</p>	<p><b>ZEISS PiWeb / PiWeb cloud</b> Visualize, store, analyze, exchange and network measurement data anywhere, even at different global sites.</p>

# ZEISS eMobility Solutions



## POWER ELECTRONICS

In order to meet the efficiency and reliability requirements of electronic components, quality assurance of semiconductor components, printed circuit boards and finished modules must be carried out on the relevant dimensions, from nanometers to millimeters.

## BATTERY

In order to enable research and development as well as quality assurance of batteries, different tools for imaging, analysis and measurement technology are required. ZEISS thus helps to provide the relevant data to improve and guarantee safety, reliability and performance.

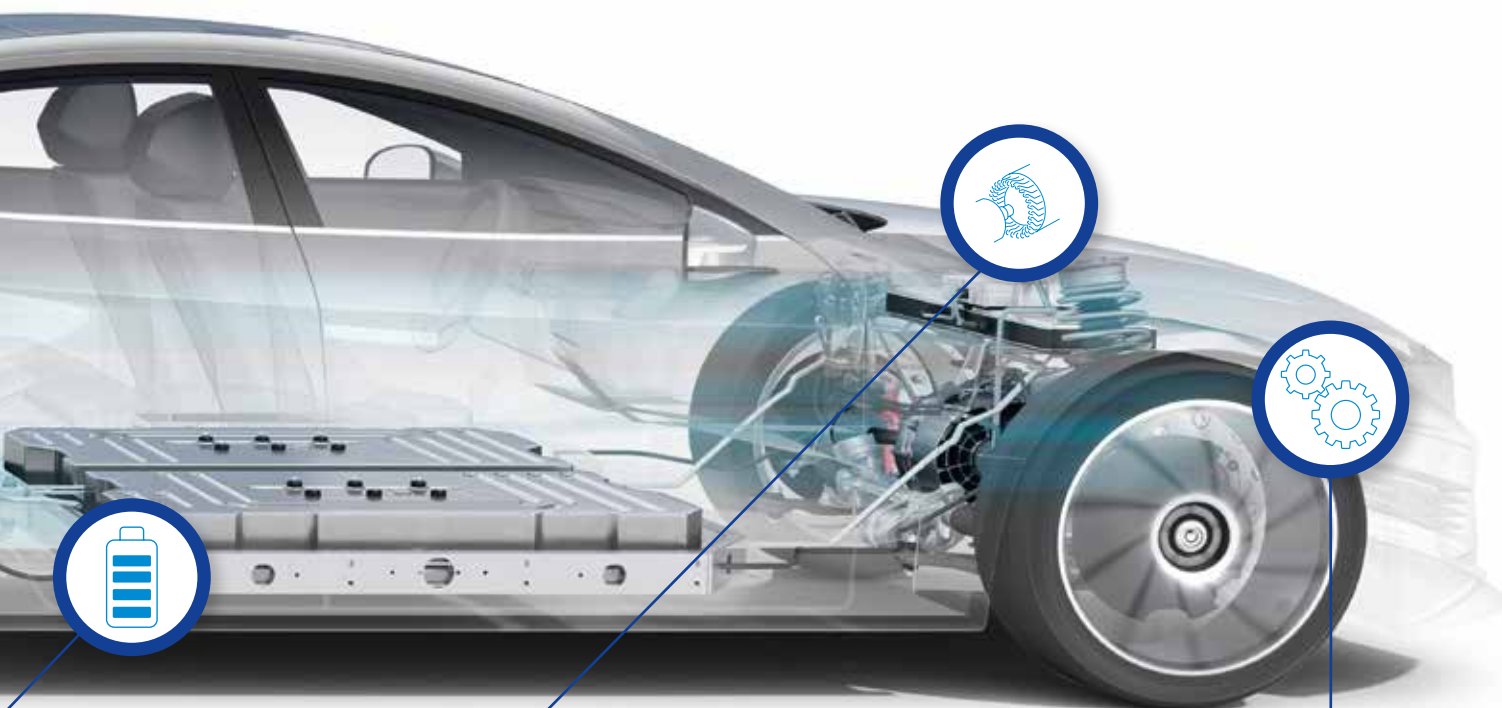

## E-MOTOR

In these engines, all components have to mesh exactly in order to combine as much power as possible with low wear. ZEISS develops and produces tactile and optical measuring systems for all areas of quality assurance and supports the manufacturers of electric motors with the necessary quality controls.

## TRANSMISSION

The drive train in electric vehicles is completely different - input or twospeed gearboxes replace up to nine gears in combustion engines. The ZEISS portfolio offers the right device for every measuring task and is in close coordination with the vehicle manufacturers and their suppliers in order to offer the best possible solution.

# Let your EDM machines do the production – we'll take care of the measurement

Washing machine

With a ZEISS coordinate measuring machine and ZEISS CALYPSO preset software, you'll be able to preset your electrodes quickly and safely. You thus will benefit not only from shorter machine setup times, but also from greater accuracy and a considerably increased productivity. Invest in your production of the future step-by-step.



**Streamline your processes and use a coordinate measuring machine to achieve more eroding throughput and measure more accurately.**

<p><b>+</b></p> <p><b>PRODUCTIVITY &amp; MACHINE EFFICIENCY</b></p>	<p><b>+</b></p> <p><b>ACCURACY &amp; PROCESS STABILITY</b></p>	<p><b>+</b></p> <p><b>WORLDWIDE COMPETITIVENESS</b></p>	<p><b>+</b></p> <p><b>PREREQUISITE FOR 24/7-PRODUCTION</b></p>
<p>Increase in productivity of all EDM machines through optimal use of the existing capacity. Shorter production times of the EDM machine with a higher throughput.</p>	<p>Higher quality and process reliability via the use of a CMM in a batch size 1 production process and the generation of ZEISS quality data.</p>	<p>In addition to faster delivery dates and a better adherence to schedules, reduced production costs and costs per component also are achieved.</p>	<p>The integration in automation processes is supported by close cooperation with the integrators and with ZEISS.</p>

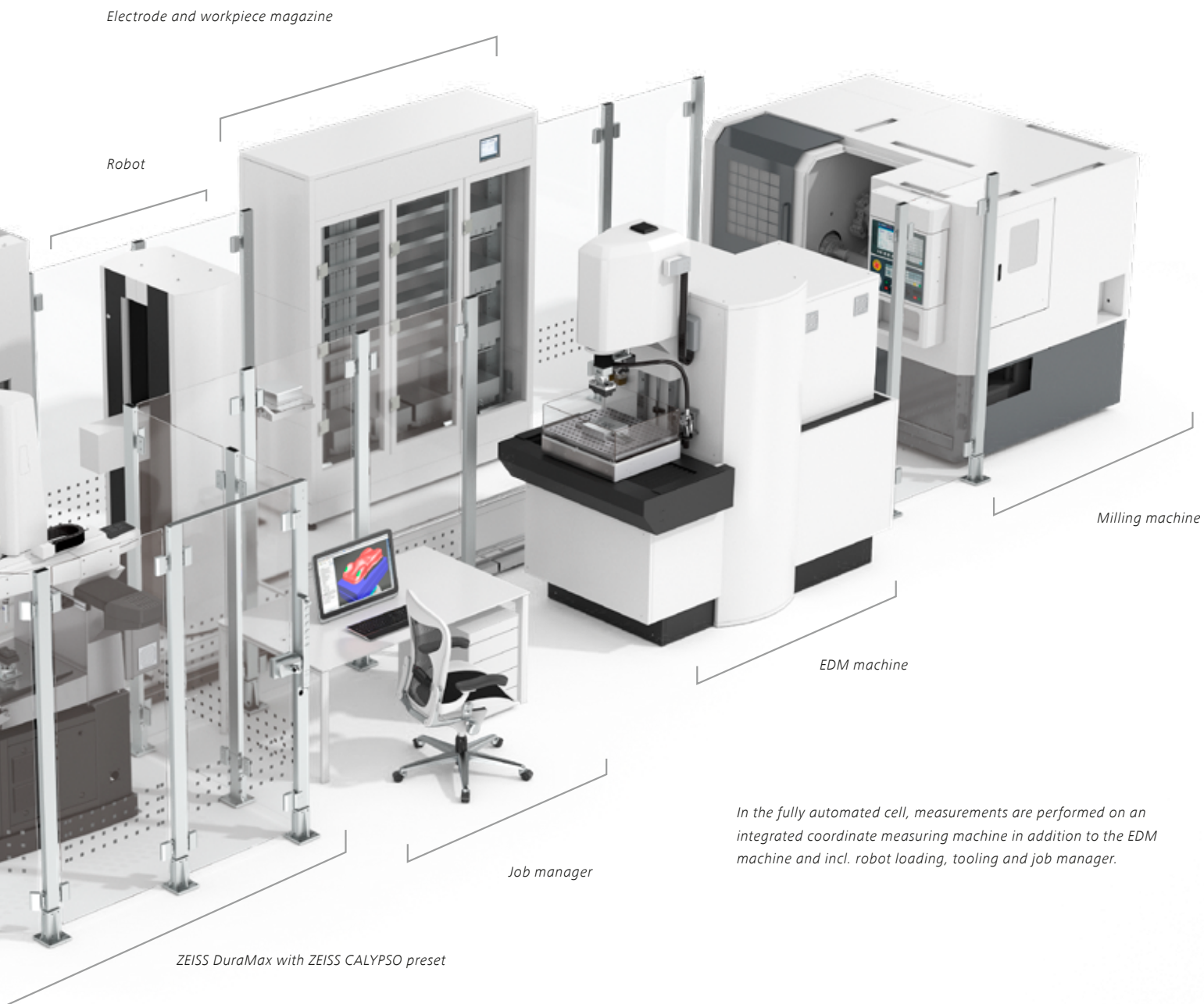

*Electrode and workpiece magazine*

*Robot*

*Milling machine*

*EDM machine*

*Job manager*

*ZEISS DuraMax with ZEISS CALYPSO preset*

*In the fully automated cell, measurements are performed on an integrated coordinate measuring machine in addition to the EDM machine and incl. robot loading, tooling and job manager.*

# ZEISS 3D ManuFACT

## The Holistic Integrated Process for Additive Manufacturing

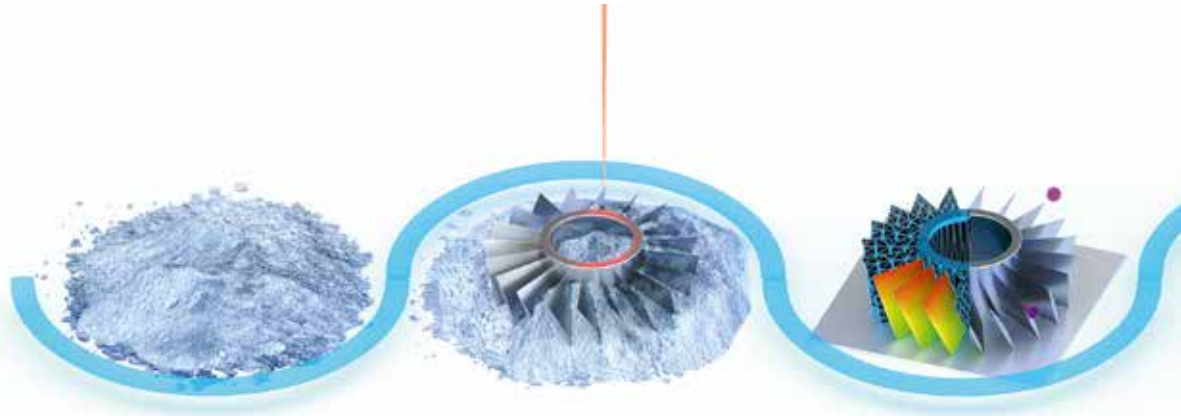

**Powder and Material Characterization**

SEM, LM, X-ray CT



**In-Process Metrology and Data Analysis**

Powder Bed Inspection



**Post-Print Heat Treatment and Part Removal**

CMM, 3D Scanning

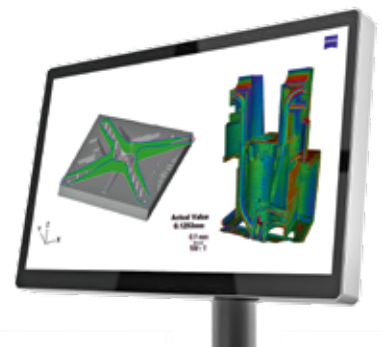
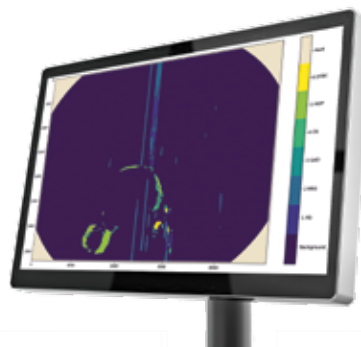
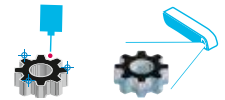

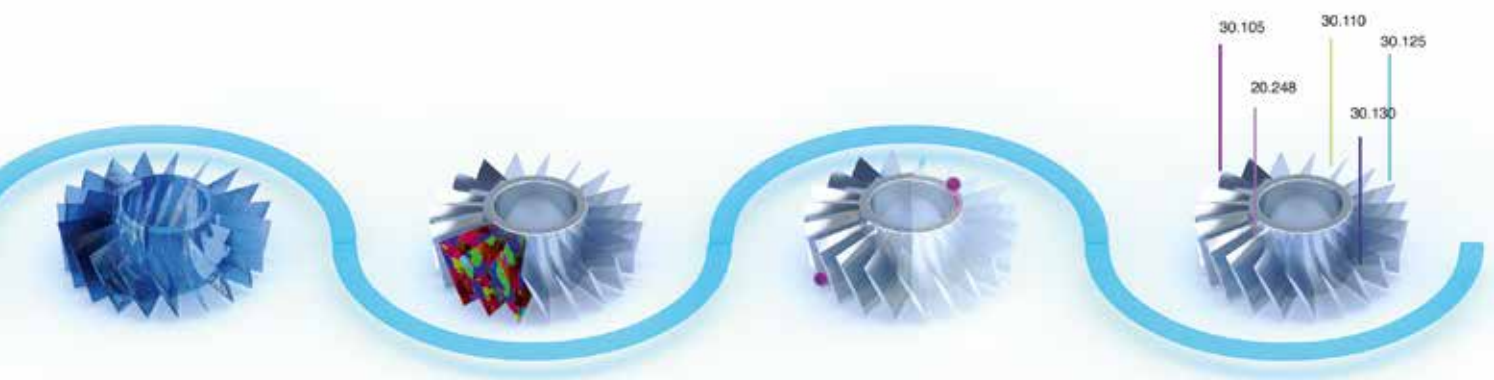

**Defect and Inner Structure Inspection**

**Post-Print Material Quality Inspection**

**Dimensional and Surface Quality Inspection**

**Process Data Statistics and Analytics**

X-ray CT, LM

SEM, LM, X-ray CT

CMM, X-ray CT, 3D Scanning, LM

PiWeb, Analytics and Correlation Tools

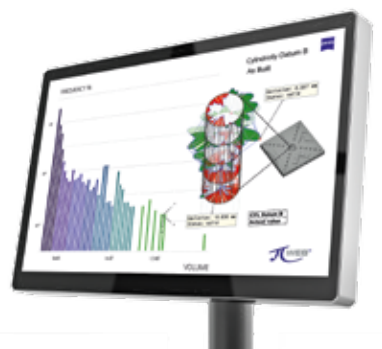
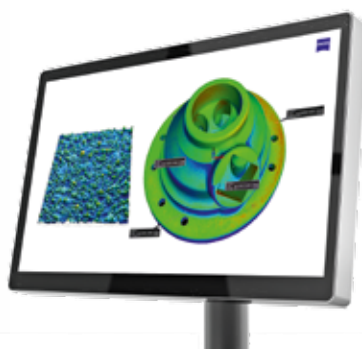
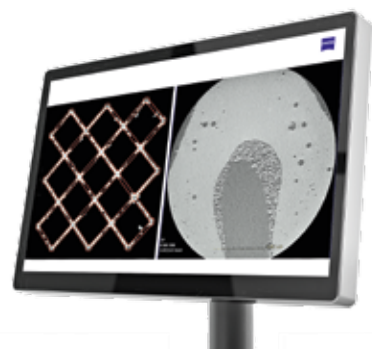

**Carl Zeiss**  
**Industrielle Messtechnik GmbH**  
73447 Oberkochen, Germany  
Sales: +49 7364 20-6336  
Service: +49 7364 20-6337  
Fax: +49 7364 20-3870  
info.metrology.de@zeiss.com  
www.zeiss.de/imt

**Carl Zeiss**  
**Industrial Metrology, LLC**  
6250 Sycamore Lane North  
Maple Grove, MN 55369/USA  
Phone: +1 763 744-2400  
Fax: +1 763 533-0219  
info.metrology.us@zeiss.com  
www.zeiss.com/metrology